

# Babushka

Łóżko 90x200

wood luck

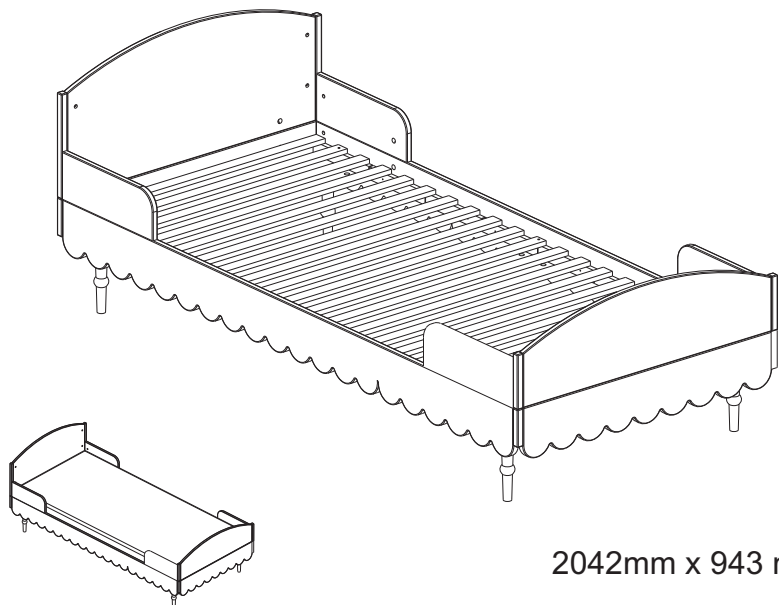

2042mm x 943 mm x 771 mm

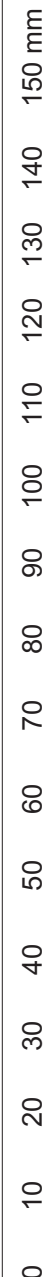
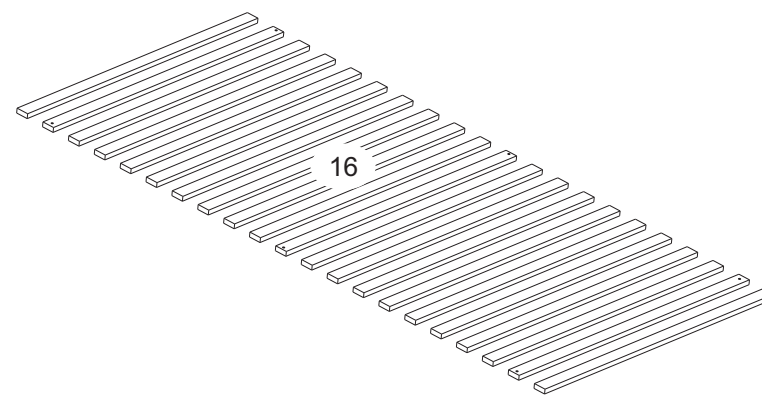
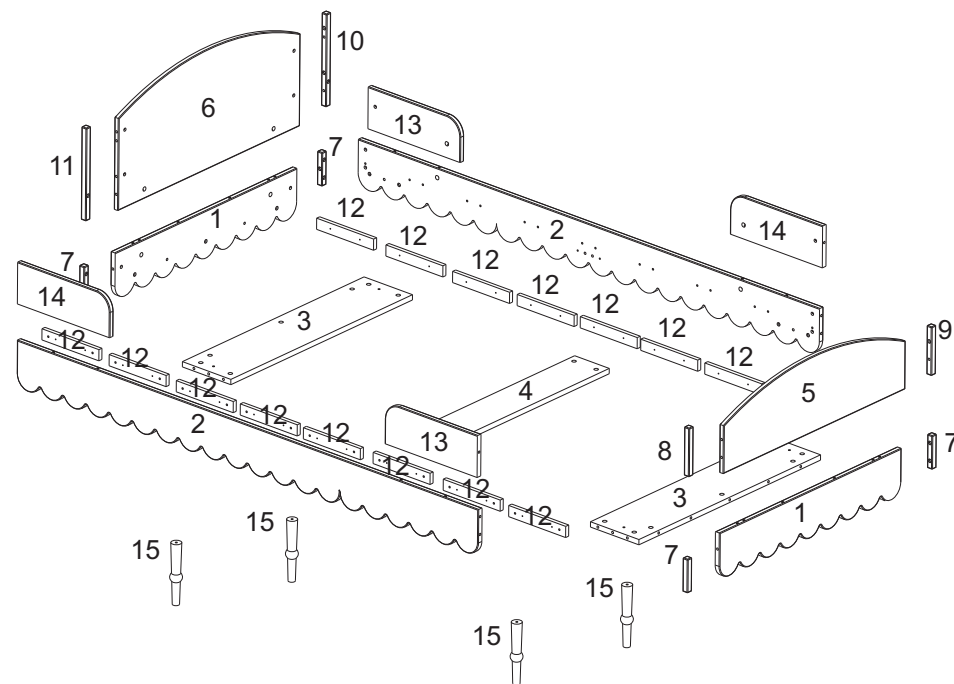
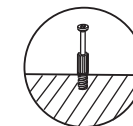
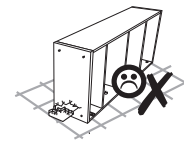
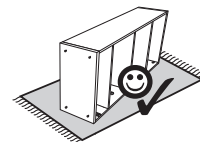
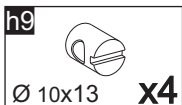
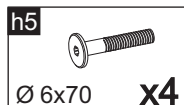
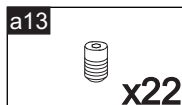
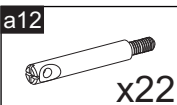
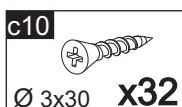
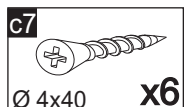
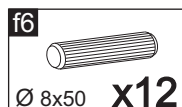
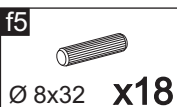
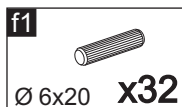
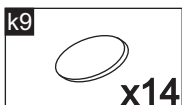
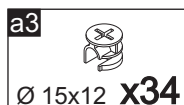
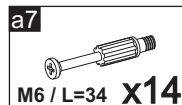
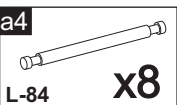
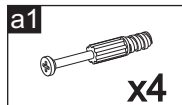
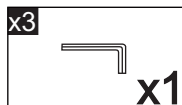
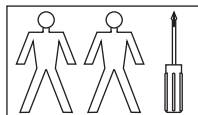

1

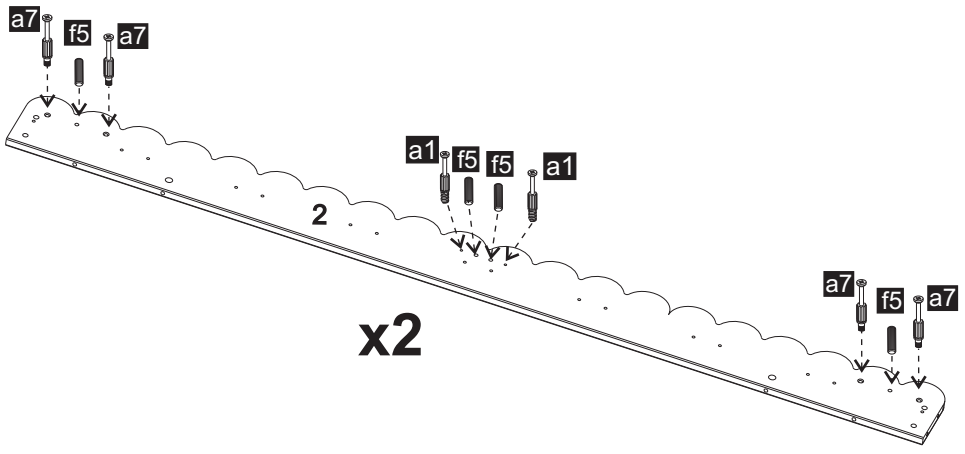
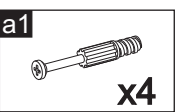
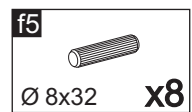
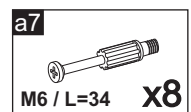

3

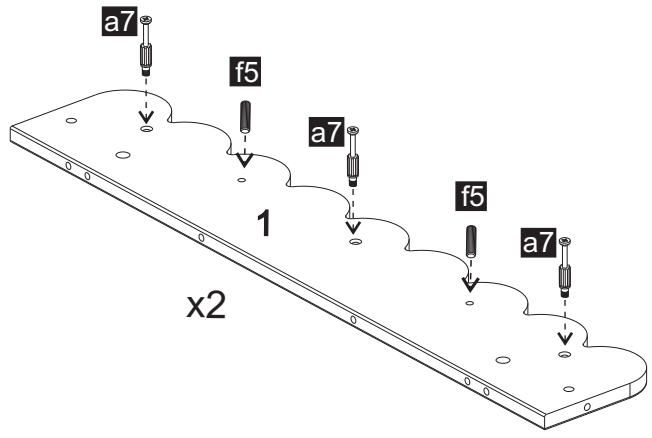
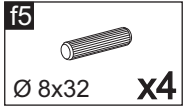
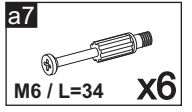

2

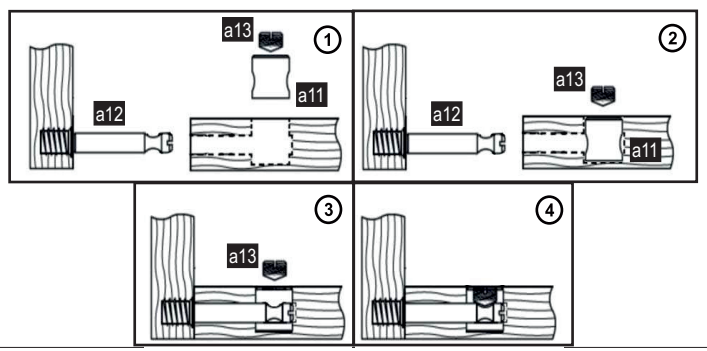
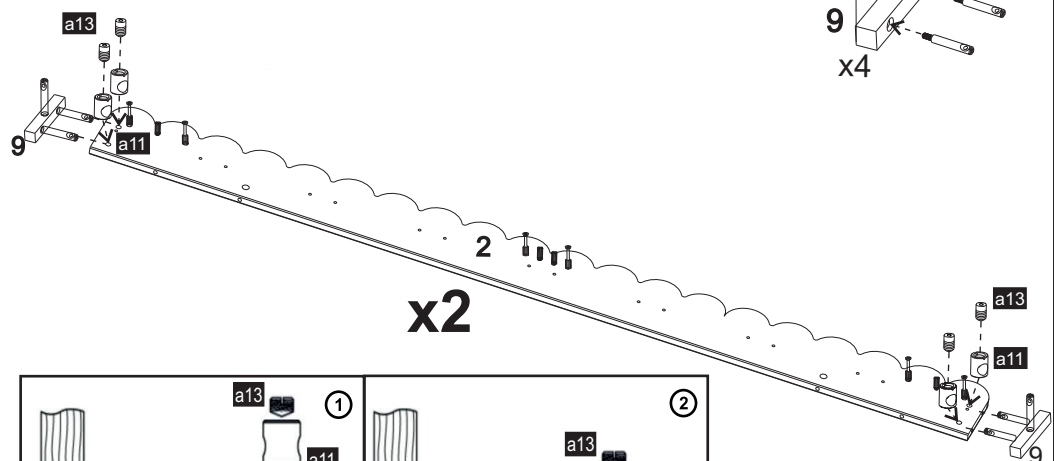
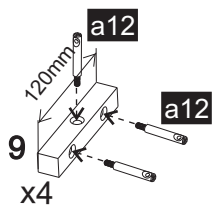
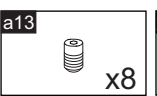
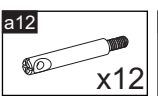

4

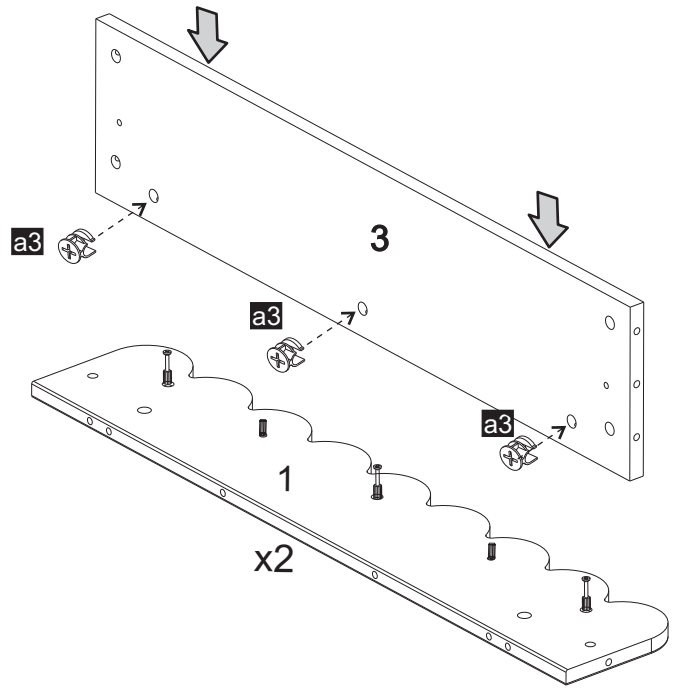
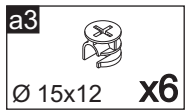

5

a11  
Ø 10x13 x2

a13  
x2

a3  
Ø 15x12 x6

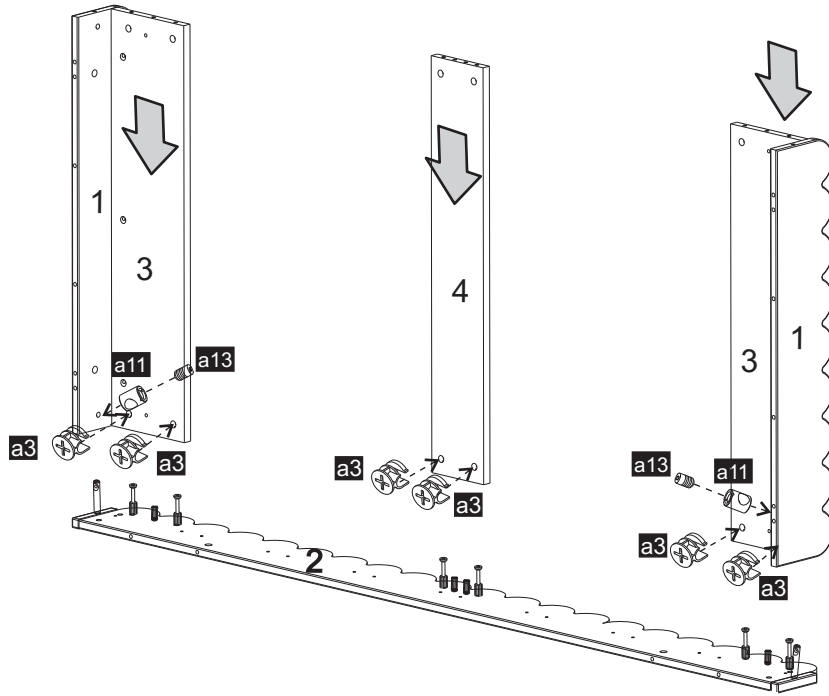

7

c10  
Ø 3x30 x32

f1  
Ø 6x20 x32

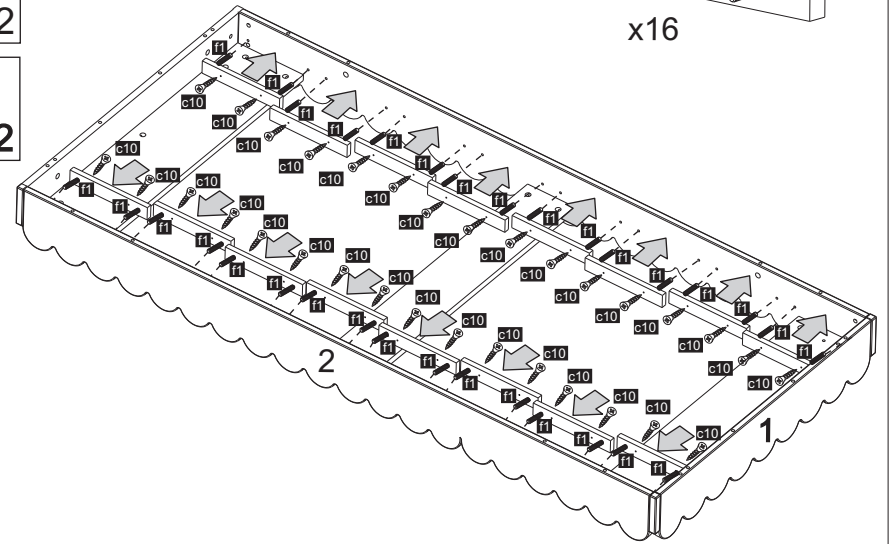
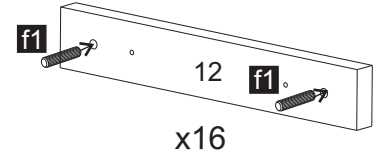

6

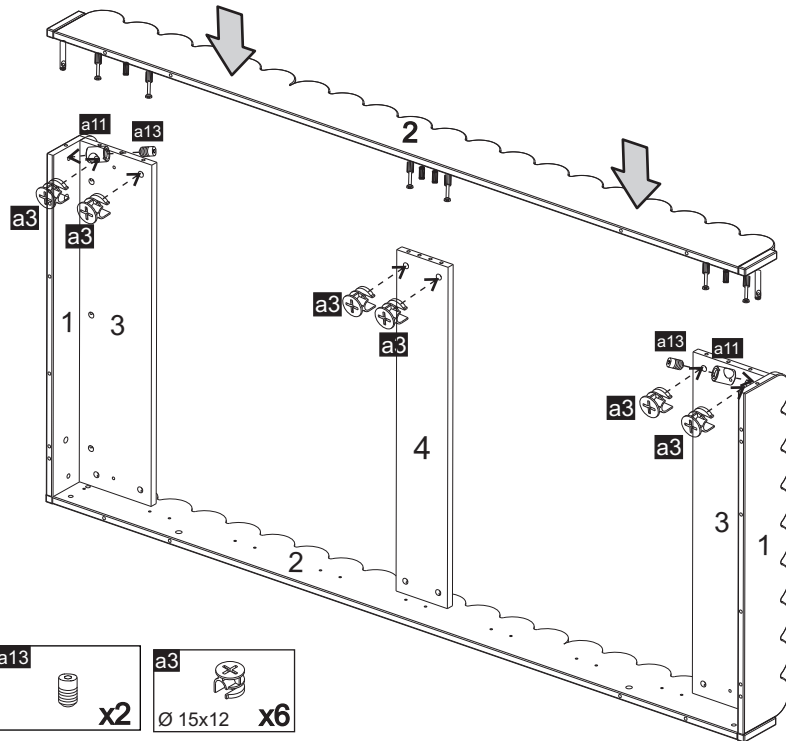

a11  
Ø 10x13 x2

a13  
x2

a3  
Ø 15x12 x6

5/10

8

h5  
Ø 6x70 x4

h9  
Ø 10x13 x4

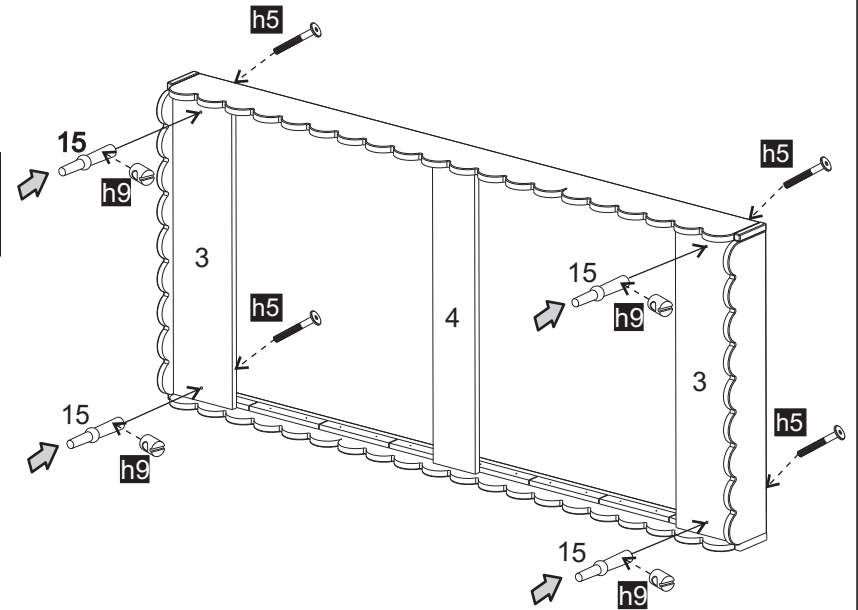

6/10

**9**

**a3**   $\varnothing 15 \times 12$  **x8**

**a4**  **x8**  
L-84

**f6**  **x12**  
 $\varnothing 8 \times 50$

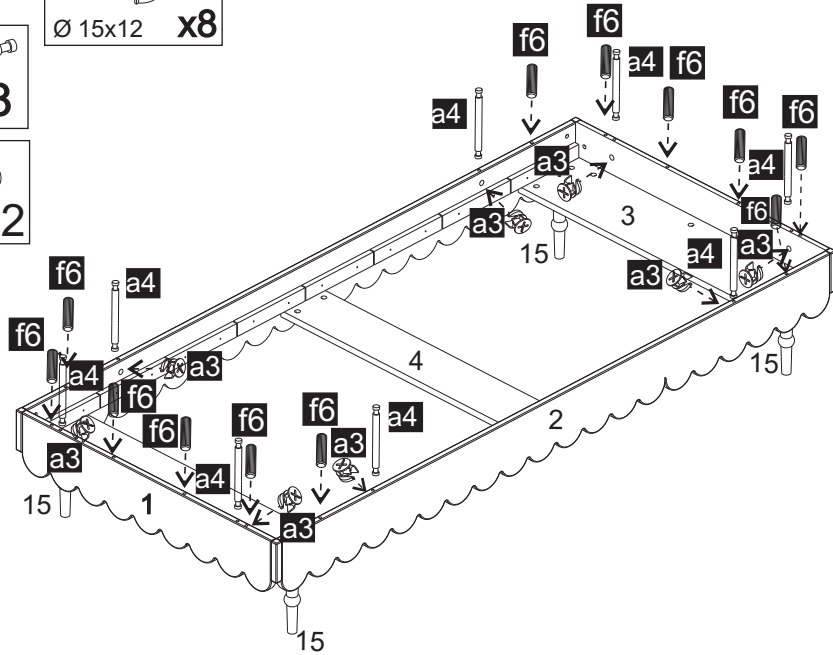

**11**

**a11**  **x2**  
 $\varnothing 10 \times 13$

**a13**  **x2**

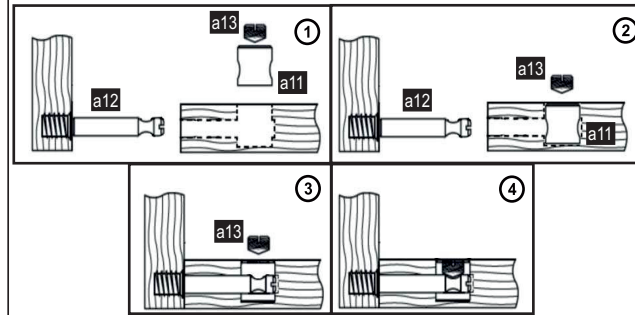
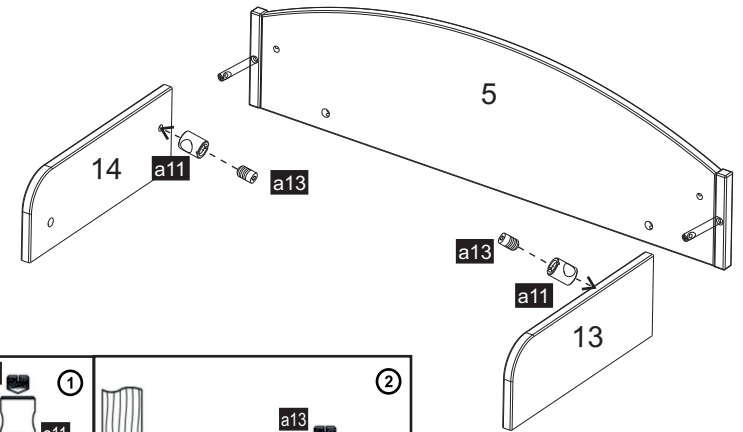

**10**

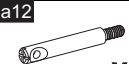
**a12**  **x4**

**a11**  **x2**  
 $\varnothing 10 \times 13$

**a13**  **x2**

**f5**  **x2**  
 $\varnothing 8 \times 32$

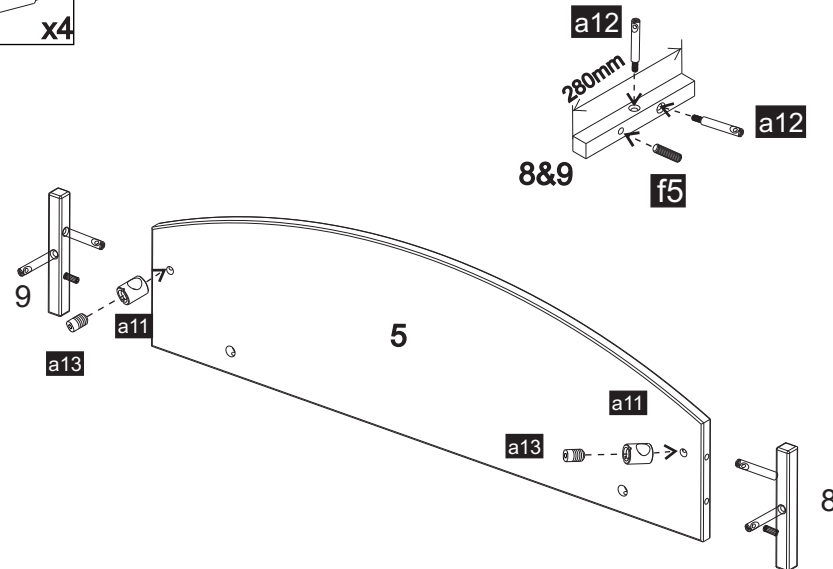

**12**

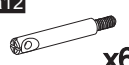
**a12**  **x6**



**a11**  **x4**  
 $\varnothing 10 \times 13$

**a13**  **x4**

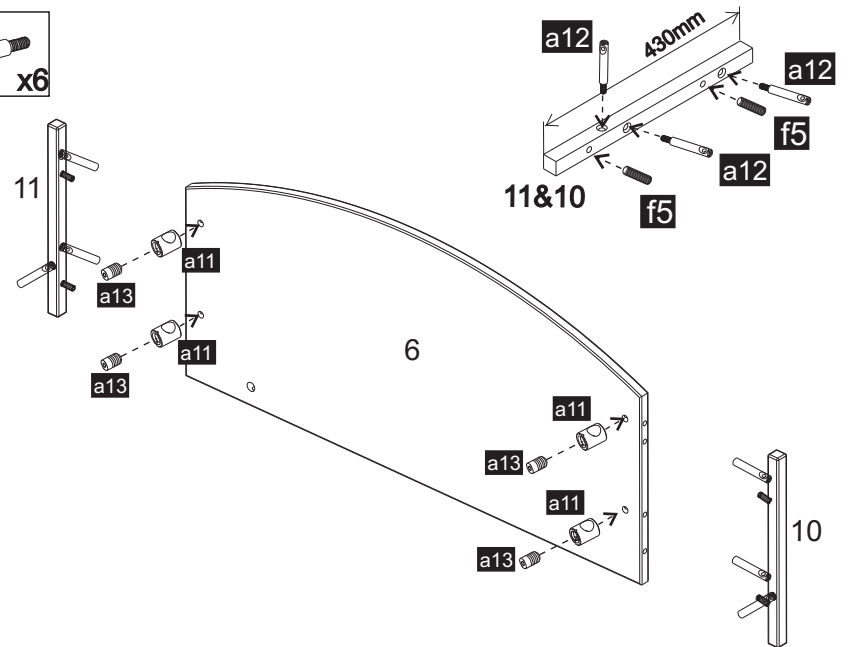
**f5**  **x4**  
 $\varnothing 8 \times 32$



13

- a11   $\varnothing 10 \times 13$  x2
- a13  x2

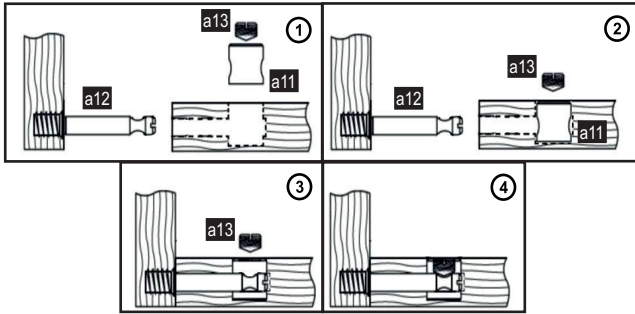
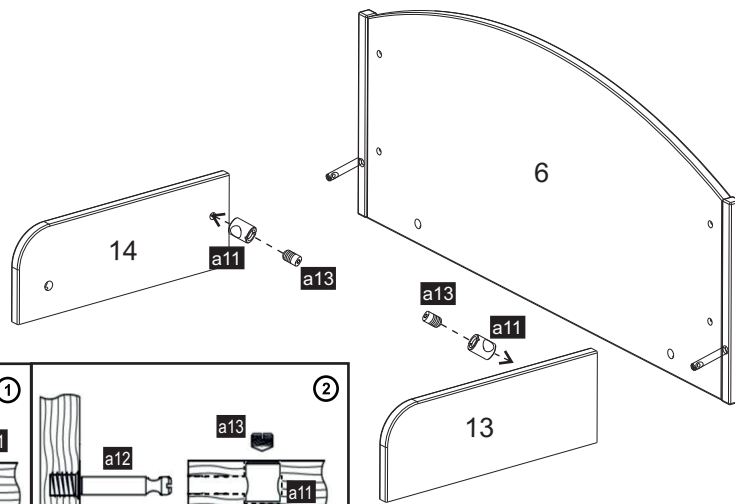

15

- a3   $\varnothing 15 \times 12$  x4
- k9  x14

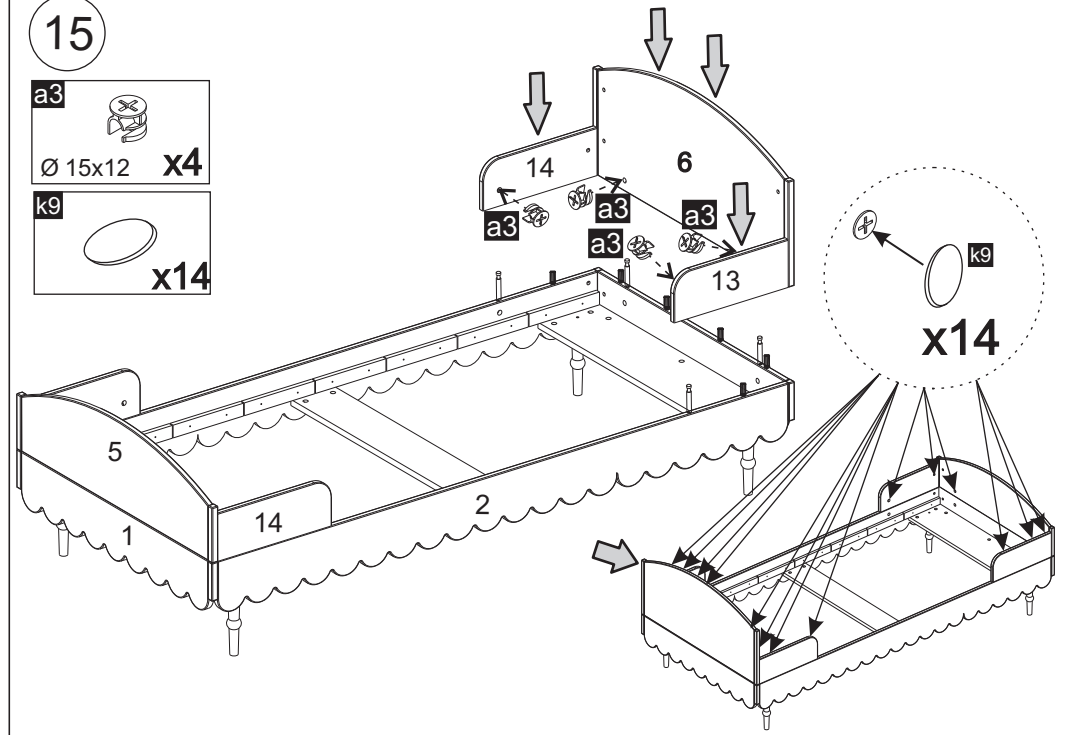

14

- a3   $\varnothing 15 \times 12$  x4

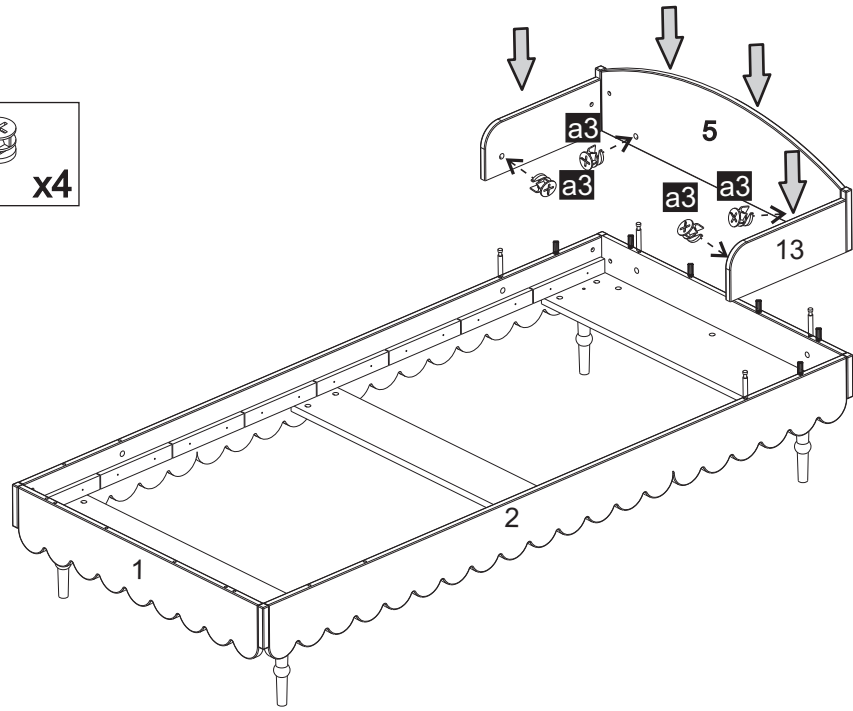

16

- c7   $\varnothing 4 \times 40$  x6

